



**BE-TECH**



# **1313K Digital Lock**

## User Manual

*Focus on Smart Lock  
Since 1992*



## IMPORTANT SAFETY INSTRUCTIONS

Please read the following safety instructions to prevent any accident, property damage and inconvenience. Children should be well educated for the operating instruction. Keep this manual in a convenient place so that you can refer to it when necessary.



**Caution** Must be followed to protect yourself and your property.

**Note**

Explains product functions and features.



Prohibited



Must observe

**Caution**

⊘ Do not use an inappropriate tool that can cause damage or malfunction of the product.



⊘ Handle the unit with care. Excessive force, careless handling may cause product damage.



! Be careful not to have an unauthorized user know your security code. Change your code periodically.



⊘ Do not use water and any type of solvent such as gasoline or benzene as they can cause damage to electronic circuit.

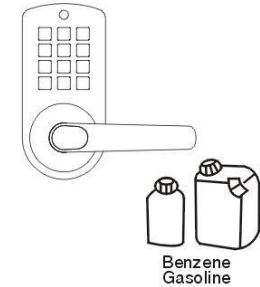

! Educate your children about the proper use of the product.



! Make sure the door is securely locked whenever you leave your house, especially in the manual lock mode.



! Keep card key reader part clean and dry. Dust off dirt smoothly with a soft cloth.



! Remove all of the batteries before installing or removing a remote control module.

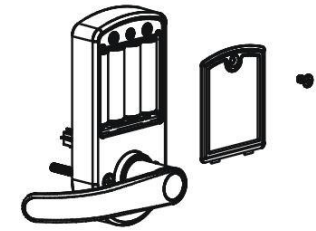

## **1 Specifications**

## **2 Identification of Product**

## **3 How to use**

- 1.Reset the lock (The lock with preset Master code 123456 and User codes 1144 (ID 01) and 2255 (ID 02)).
- 2.Change Master code
- 3.Setting User code
- 4.Change your own User code
- 5Automatic/Manual Lock Mode
- 6.Locking the door from the outside
- 7.Unlocking the door from the outside
- 8.Turning sound on/off
- 9.Enable/Disable holiday mode
- 10.Unlocking the door from the inside
- 11.Wrong-try Lock-out
- 12.Battery use & Replacement

## **4 Cautions**

- 1.For deleting some of User code
- 2.For deleting all User codes at a time
- 3.For losing Master code
- 4.Scramble code
- 5.Emergency mechanical key override

# 1 Specifications

Parts	Specifications	Remarks
Front(Front Body)	65(W)x138(H)x20.5(D)(76.5)mm, stainless steel	Operating temperature:-10~60 ° C
Back(Back Body)	65(W)x138(H)x20.5(D)(59)mm, stainless steel	
Handle	Zinc Alloy	
Master Code	Setting Function	1 Group (4~9 Digits)
User Codes	Unlock/Lock	15 Groups (4~9 Digits)
Battery	4 EA 1.5V AA alkaline batteries (Operating voltage:4.5~6V)	Last up to 12 months(10 times used a day)
Lock case	Steel	

※Battery life may vary depending on temperature, moisture levels, frequency of use and the quality of the batteries.

※Please make sure that all parts are included when purchasing the product.

※Optional products may not be available depending on your country or local dealer.

## ■ Basic Contents



Front Lock



Back Lock

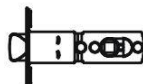

Mortise

- Emergency keys
- Screws
- Installation Template
- Users Manual

# 2 Identification of Product

## 1. Front (Front Body, install on the outside of the door)

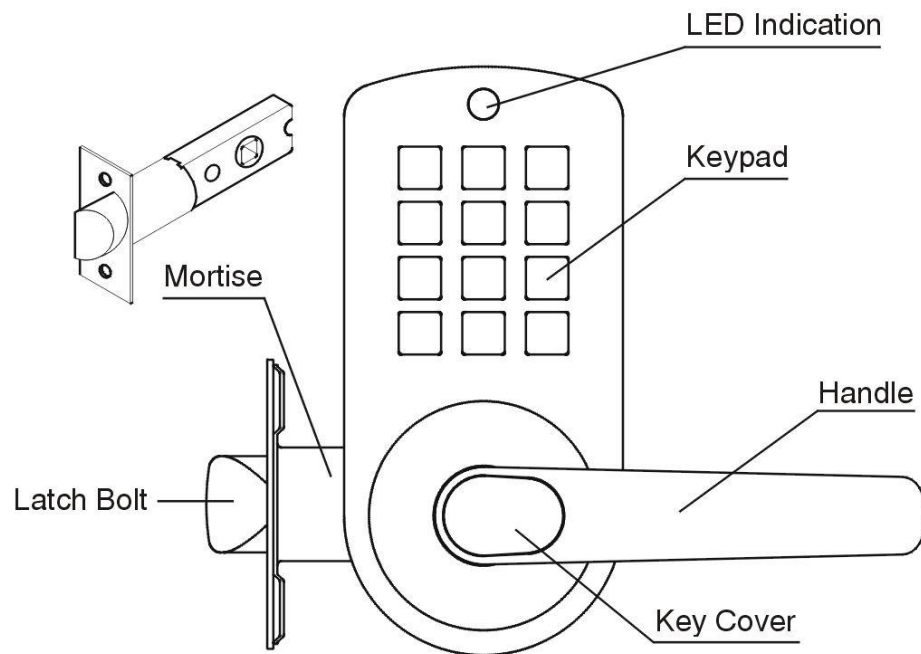

### Take out key cover

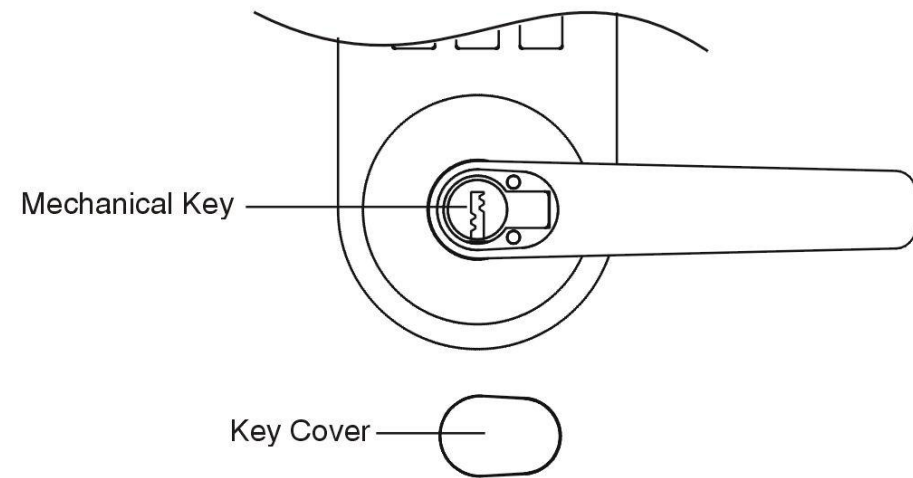

## 2.Back (Back Body, install on the inside of the door)

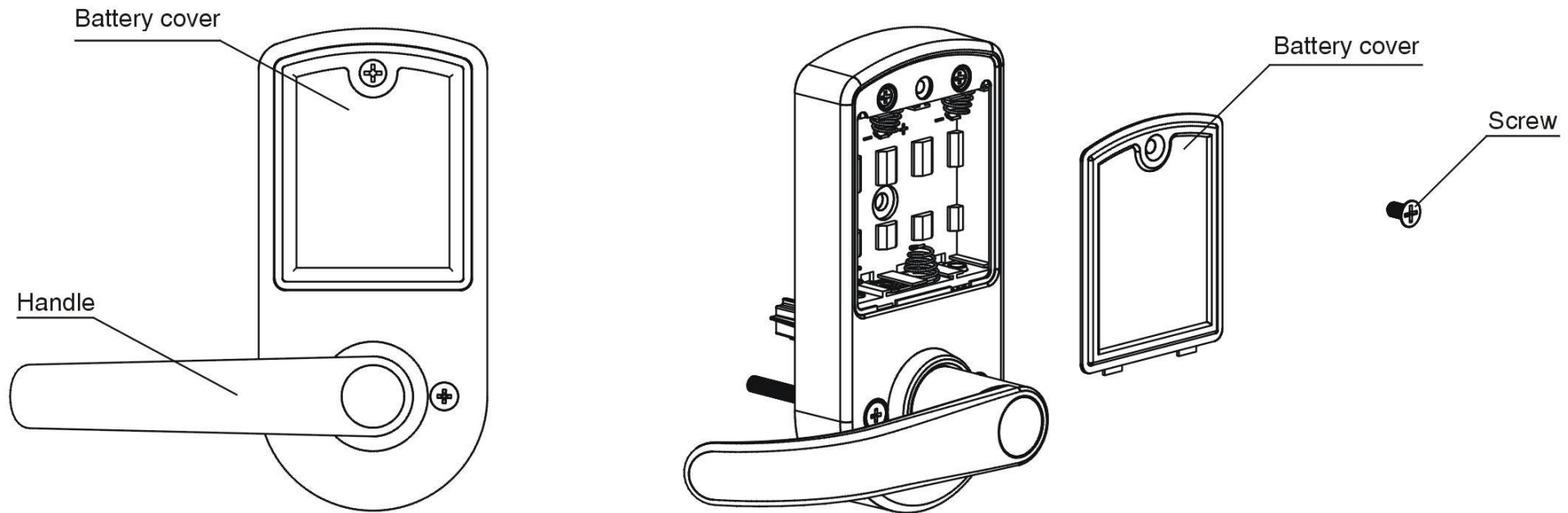

# 3 How to Use

## 1. Reset the lock

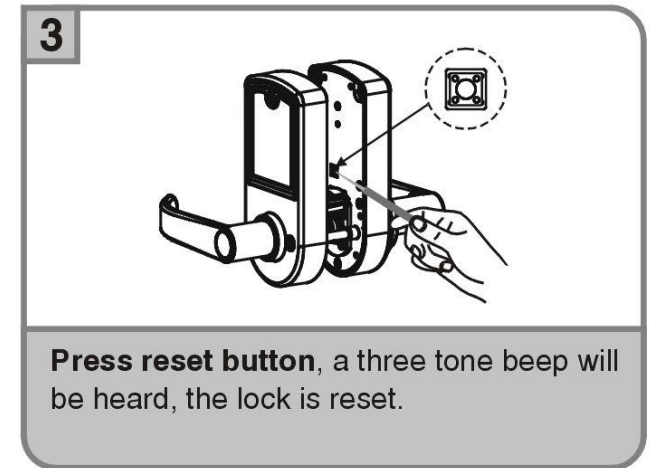
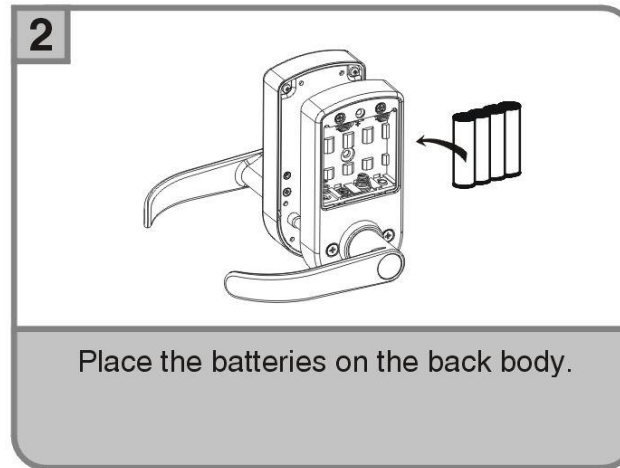
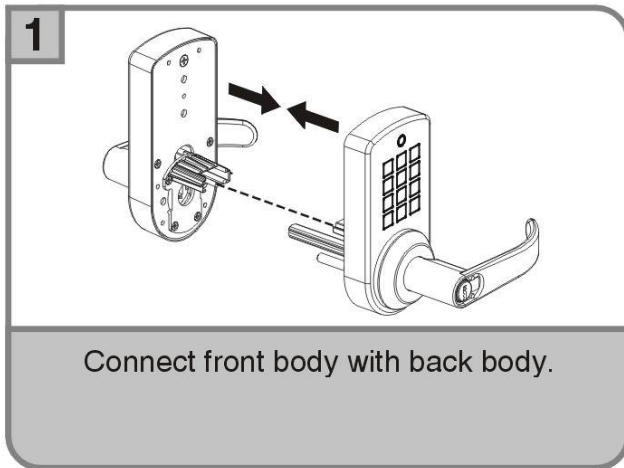

### Note

- The lock with preset Master code 123456 and User codes 1144 (ID 01) and 2255 (ID 02) after reset.
- Under unlock state, avoid damaging the lock, please don't try to open the lock with Mechanical key.



## 2.Change Master Code

### Caution

- Keep the door open while you set Master code to prevent yourself from accidentally getting locked out.

1



Press **\*** → **1** → **#**, a single tone beep will be heard and yellow LED light will flash.

2

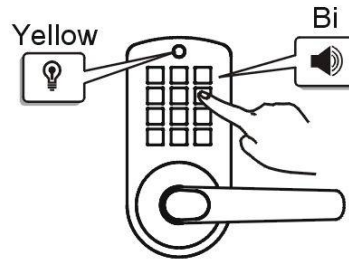

While the yellow LED light is flashing, **enter 123456** → **#**, a single tone beep will be heard and yellow LED light will flash.

3

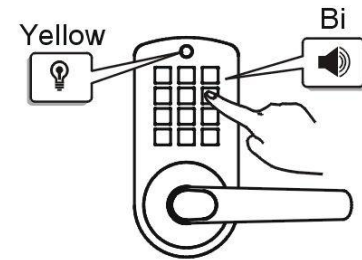

While the yellow LED light is flashing, **enter the code you want to register(4-9 digits)** → **#**, a single tone beep will be heard and yellow LED light will keep flashing.

4

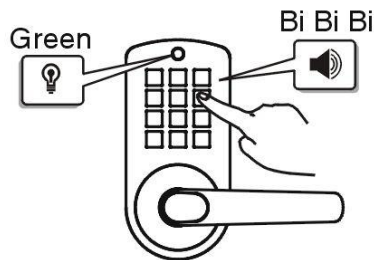

While the yellow LED light is flashing, **repeat entering the codes** → **#**, a three tone beep will be heard and green LED light will flash thrice, new Master code is registered.

### Note

- Only one Master code is accepted by the lock.
- Master code can not open the lock.

# 3. Setting User Code



## Caution

- Keep the door open while you set User code to prevent yourself from accidentally getting locked out.

1



Press **\*** → **2** → **#**, a single tone beep will be heard and yellow LED light will flash.

2

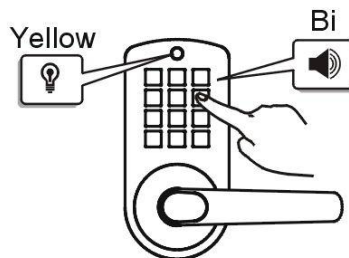

While the yellow LED light is flashing, **enter Master code** → **#**, a single tone beep will be heard and yellow LED light will flash.

3

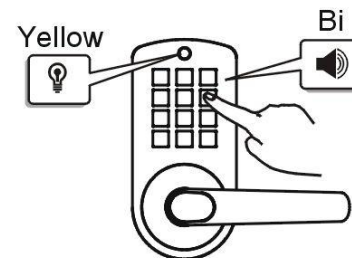

While the yellow LED light is flashing, **enter the ID number (01-15)** → **#**, a single tone beep will be heard and yellow LED light will flash.

4

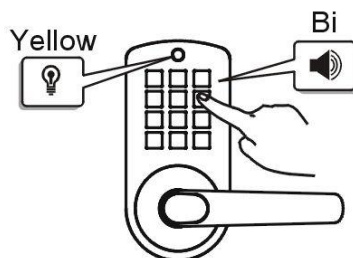

While the yellow LED light is flashing, **enter the code you want to register (4-9 digits)** → **#**, a single tone beep will be heard and yellow LED light will flash.

5

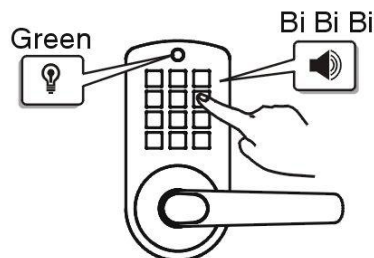

While the yellow LED light is flashing, **repeat entering the codes** → **#**, a three tone beep will be heard and green LED light will flash thrice, User code is registered.

6



Check your User code once registration is completed; make it sure to open the lock with your User code. **enter User code** → **#** to unlock.

## Note

- Because of the preset User codes 1144 and 2255, the ID of them are 01 and 02 used, you have to start up the ID for your User code by 03, or delete the preset User codes before your registration (please read on page 20). You can set total 15 groups of Use code for the lock.

# 4. Change your own User code

## Caution

- Keep the door open while you register User code to prevent yourself from accidentally getting locked out.

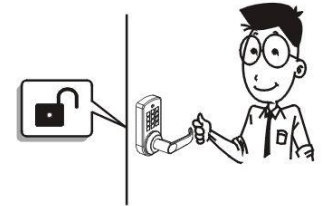

1



Press **\*** → **4** → **#**, a single tone beep will be heard and yellow LED light will flash.

2

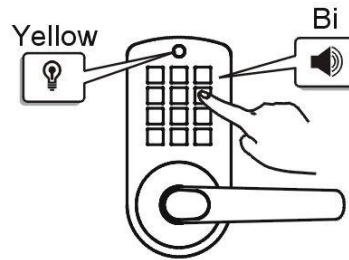

While the yellow LED light is flashing, **enter the User code which you want to change** → **#**, a single tone beep will be heard and yellow LED light will flash.

3

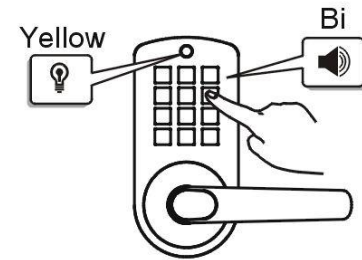

While the yellow LED light is flashing, **enter new User code (4-9 digits)** → **#**, a single tone beep will be heard and yellow LED light will keep flashing.

4

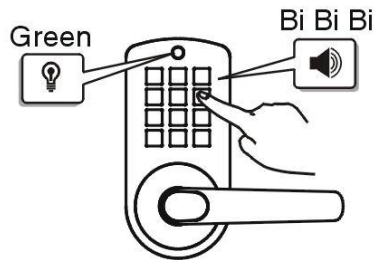

While the yellow LED light is flashing, **enter same User code again** → **#**, a three tone beep will be heard and green LED light will flash thrice, that user code is set.

# 5. Automatic/Manual Lock Mode



## Caution

- Automatic lock mode is a factory default setting, and it will automatically lock the door in 4 seconds after opening.

### Setting Automatic lock mode

If the lock is under manual lock mode

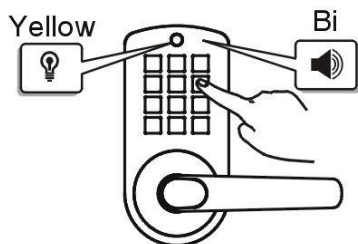

Press **\*** → **7** → **#**, a single tone beep will be heard and yellow LED light will flash.

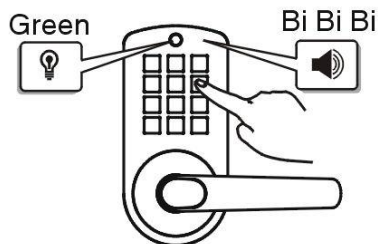

While the yellow LED light is flashing, **enter Master code** → **#**, a three tone beep will be heard and green LED light will flash thrice, the lock is set to automatic lock mode.

### Setting Manual lock mode

If the lock is under automatic lock mode

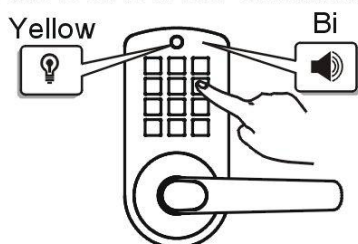

Press **\*** → **7** → **#**, a single tone beep will be heard and yellow LED light will flash.

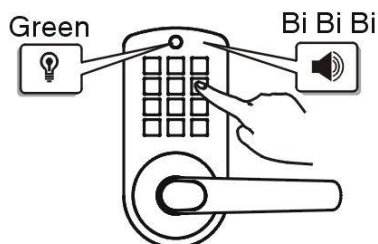

While the yellow LED light is flashing, **enter Master code** → **#**, a three tone beep will be heard and green LED light will flash thrice, the lock is set to Manual lock mode

## 6.Locking the door from the outside

※ Please check Automatic/Manual Lock mode

### Under Automatic lock mode

When you unlock the lock, green LED light will flash 1 time, the lock will lock automatically within 4 seconds and green LED light is off.

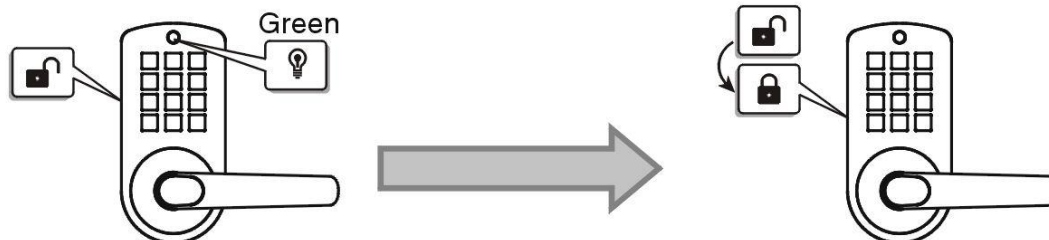

### Under Manual lock mode

Press #

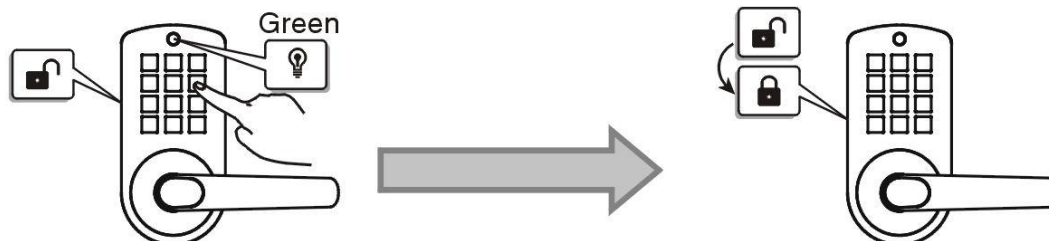

### Caution

- As the automatic lock function does not work in manual lock mode, make sure to check that the door is securely locked when leaving the premises.

# 7.Unlocking the door from the outside

## Unlocking the door with User code

1

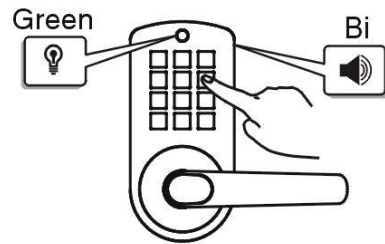

Key in User code → #

2

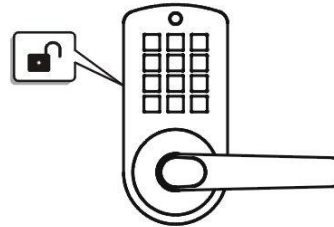

Confirming the door open.

## 8. Turning sound on/off

### When sound on

1

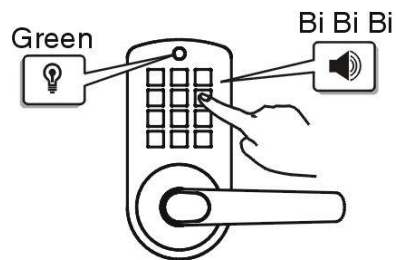

Press **\*** → **5** → **#**, A three tone beep will be heard and green LED light will flash thrice, there is buzzer when operating the lock.

### When sound off

1

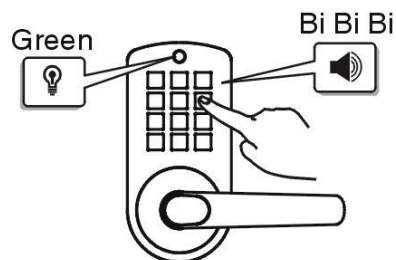

Press **\*** → **5** → **#**, A three tone beep will be heard and green LED light will flash thrice, there is no buzzer when operating the lock.

## 9.Enable/Disable holiday mode

### When holiday mode

1

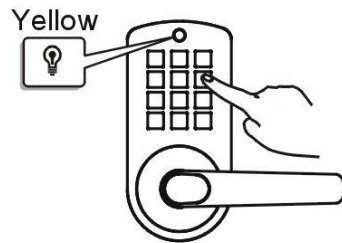

Press **\*** → **6** → **#**, a single tone beep will be heard and yellow LED light will flash.

2

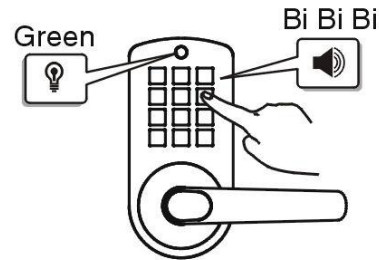

While the yellow LED light is flashing, **enter Master code** → **#**, a three tone beep will be heard and green LED light will flash thrice, holiday mode is disabled.

### Note

- User codes are not available for unlocking when holiday mode, unless you set back to normal mode.

### When Normal mode

1

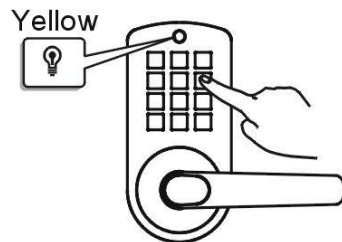

Press **\*** → **6** → **#**, a single tone beep will be heard and yellow LED light will flash.

2

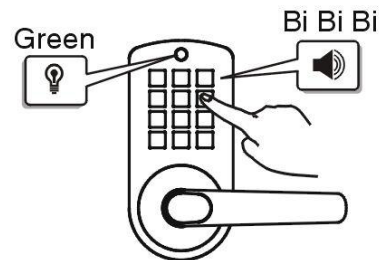

While the yellow LED light is flashing, **enter Master code** → **#**, a three tone beep will be heard and green LED light will flash thrice, holiday mode is enabled.



## 10.Unlocking the door from the inside

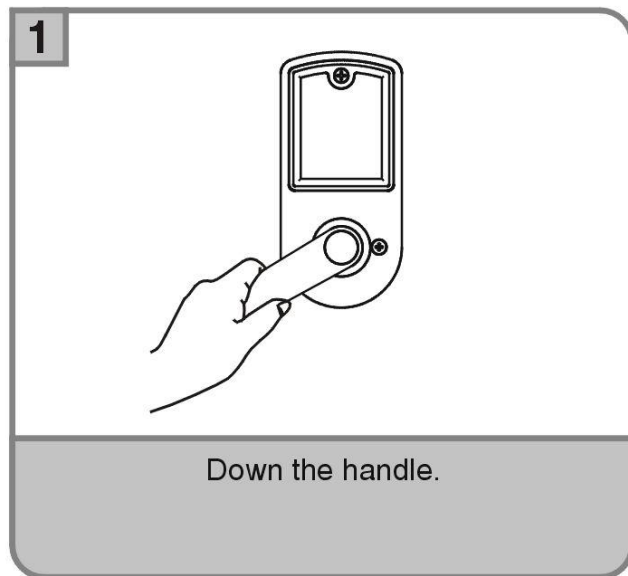

# 11. Wrong-try Lock-out

If incorrect User code are attempted 3 times in a row, it will lock-out about 2 minutes with flashing red LED light.

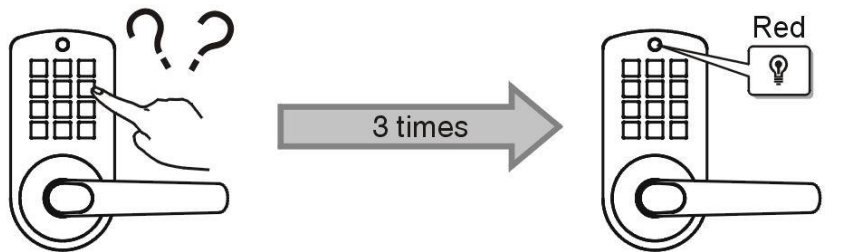

This system will resume the operation automatically after 2 minutes of lock-out.

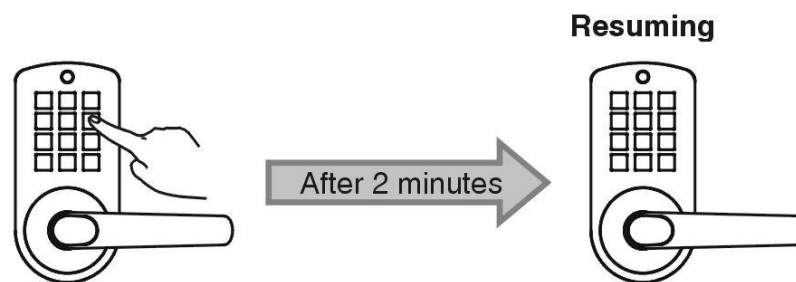

# 12. Battery use & Replacement.

This product uses 4 1.5V alkaline AA batteries which can be used approximately one year on the condition of 10 times open/close cycles per day.



Battery life may vary due to temperature moisture, frequency of use and the quality of the batteries.

## Battery replacement warning

Replace all 4 batteries when a low battery warning sound rings and red LED light under unlock the lock.

## Extremely low voltage

The red Led light will flash once in every 5s which is indicating extremely low voltage. It will be resumed after changing new battery and unlock.

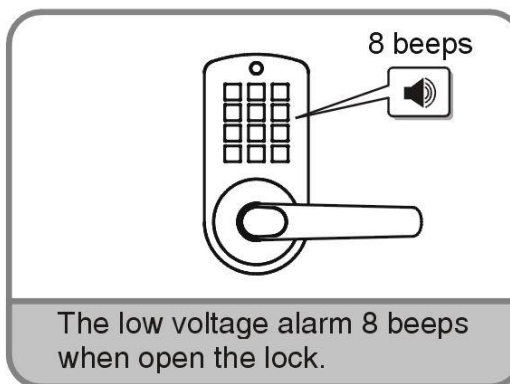

The low voltage alarm 8 beeps when open the lock.



Do not mix new and used batteries.

## Caution

- Always check ' + ' and ' - ' directions when inserting batteries.
- Use the authentic alkaline batteries. It is an user`s responsibility for damage caused by using unauthentic batteries.
- Risk of explosion if battery is replaced by an incorrect type.
- Dispose of used batteries according to the instructions.

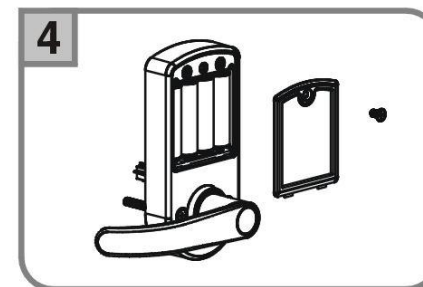
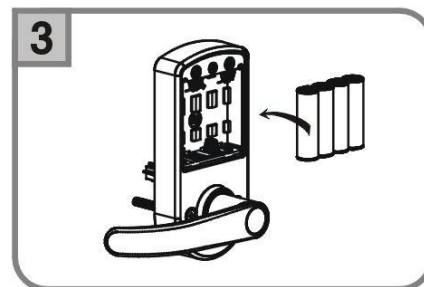
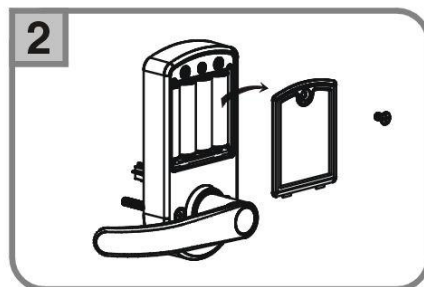
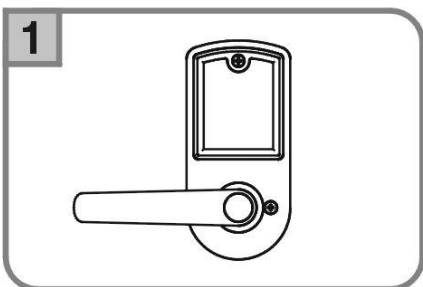

# 4 Cautions

## 1. For deleting some of User code

**1**

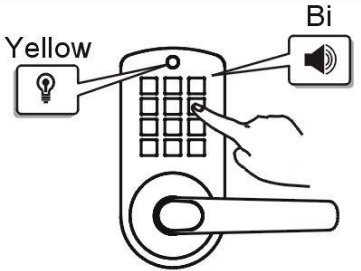

Yellow

Bi

Press **\*** → **3** → **#**, a single tone beep will be heard and yellow LED light will flash.

**2**

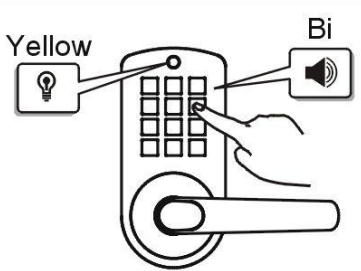

Yellow

Bi

While the yellow LED light is flashing, **enter Master code** → **#**, a single tone beep will be heard and yellow LED light will flash.

**3**

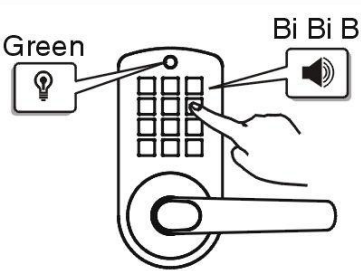

Green

Bi Bi Bi

While the yellow LED light is flashing, **enter the ID number (01-15) of the User code you want to delete**, a three tone beep will be heard and green LED light will flash thrice, that user code is deleted.

## 2. For deleting all User codes at a time

**1**

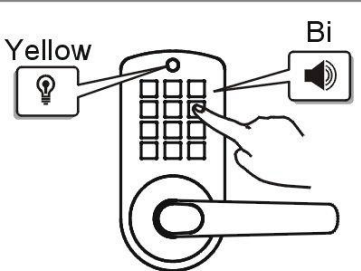

Yellow

Bi

Press **\*** → **0** → **#**, a single tone beep will be heard and yellow LED light will flash.

**2**

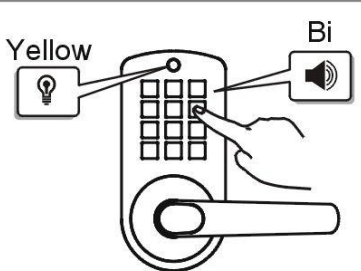

Yellow

Bi

While the yellow LED light is flashing, **enter Master code** → **#**, a single tone beep will be heard and yellow LED light will flash.

**3**

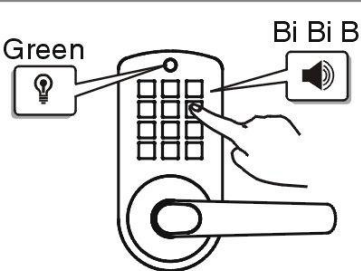

Green

Bi Bi Bi

While the yellow LED light is flashing, **enter Master code again** → **#**, a three tone beep will be heard and green LED light will flash thrice, all User codes are deleted.

### 3. For losing Master code

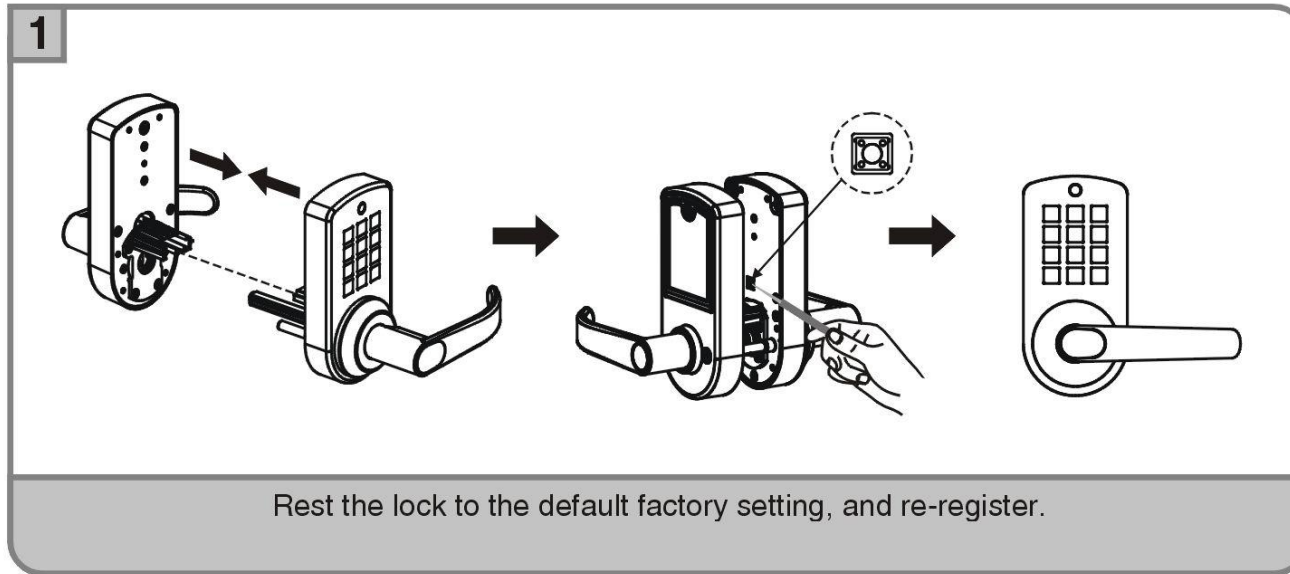

### 4. Scramble code

You can enter meaning less number prior to the right code when there is chance of exposing it to others, but the total numbers should be less than 20 digits, otherwise it would be error.

## 5. Emergency mechanical key override.

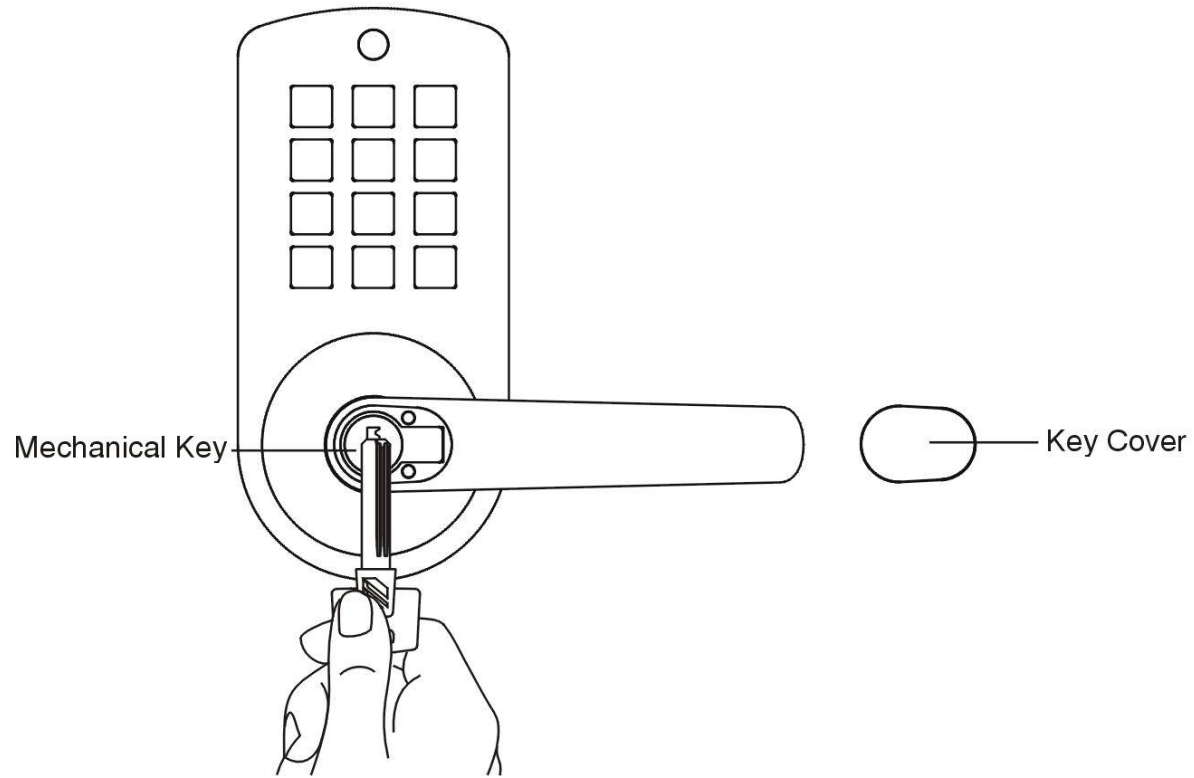

# Programming Guide

List	Description
* → 1 → #	To set new Master code
* → 2 → #	To set User code
* → 3 → #	To delete some User code
* → 0 → #	To delete all User codes at a time
* → 5 → #	To turn sound on/off
* → 6 → #	To enable/disable holiday mode
* → 7 → #	To set automatic lock mode/manual lock mode

## LED Light Indication introduction

Successful operation	Green light flashes once
Wrong operation	Red light flashes once
Low voltage warning	Red light flashes 8 times
Unlock	Green light flashes once
Lock	Red light flashes twice
Incorrect code	Red light flashes 4 times
Incorrect code operates thrice	Red light flashes 60s

*Smart Your Life*

**GUANGDONG BE-TECH SECURITY SYSTEMS LIMITED**

Add: No.17, Keyuan 3 Road, Ronggui, Shunde High-Tech Zone, Foshan,  
Guangdong, P.R.China.

Tel: 86-757-2830 88333 Fax: 86-757-2830 8823

<http://www.be-tech.com.cn>

Email: [export@be-tech.com.cn](mailto:export@be-tech.com.cn)